

1 January 2016

By: KÇ



**STOCKMAN
STONWORKS**

OUTDOOR FIREPLACE KIT

Build Guide

Step 1

ITEM	Quantity
Simplicity 	26

"For ease of installation a cement pad is recommended." If concrete is not an option a pad of gravel will suffice. Insure to use a 1" Rock or comparable size, at least 2 inches thick, compacted on solid ground. Using a straight edge (i.e. 4' level or 2 x 4 Square) pick a starting side and begin leveling your blocks one at a time, using your straight edge as a guide.

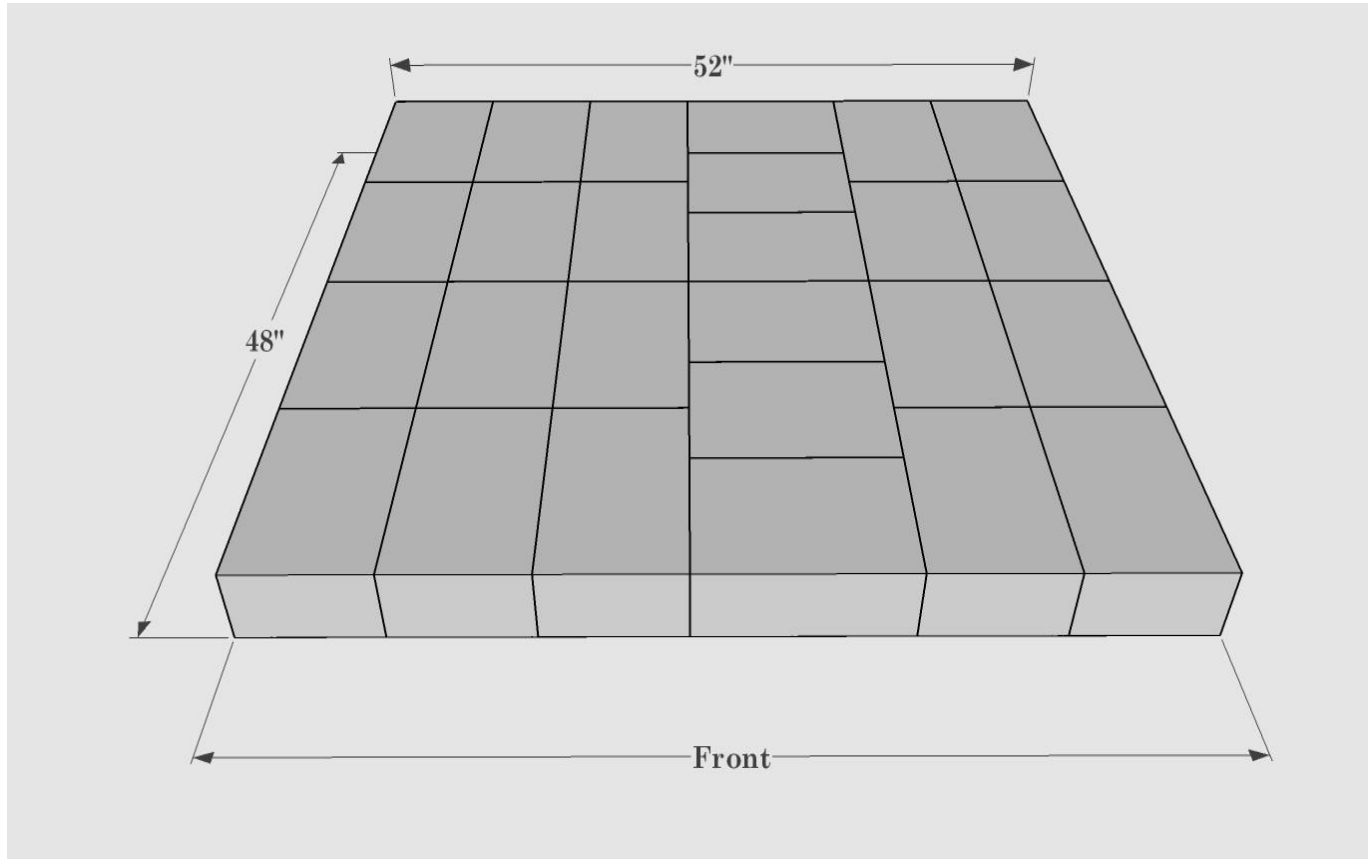

Step 2

ITEM	Quantity
Simplicity	26
Glue	



26

Glue



Once your base is level, thoroughly brush off the top to ensure proper bonding. Clean your second layer blocks also and begin laying your second course, gluing all blocks. Gluing sides is not necessary. Again use your straight edge and square to keep everything plumb.

Important Note As you glue, gently tap block with your Dead blow to evenly distribute the glue between adjoining faces.

Important Note Take Caution, as freshly glued blocks will easily slide around until glue begins to set.

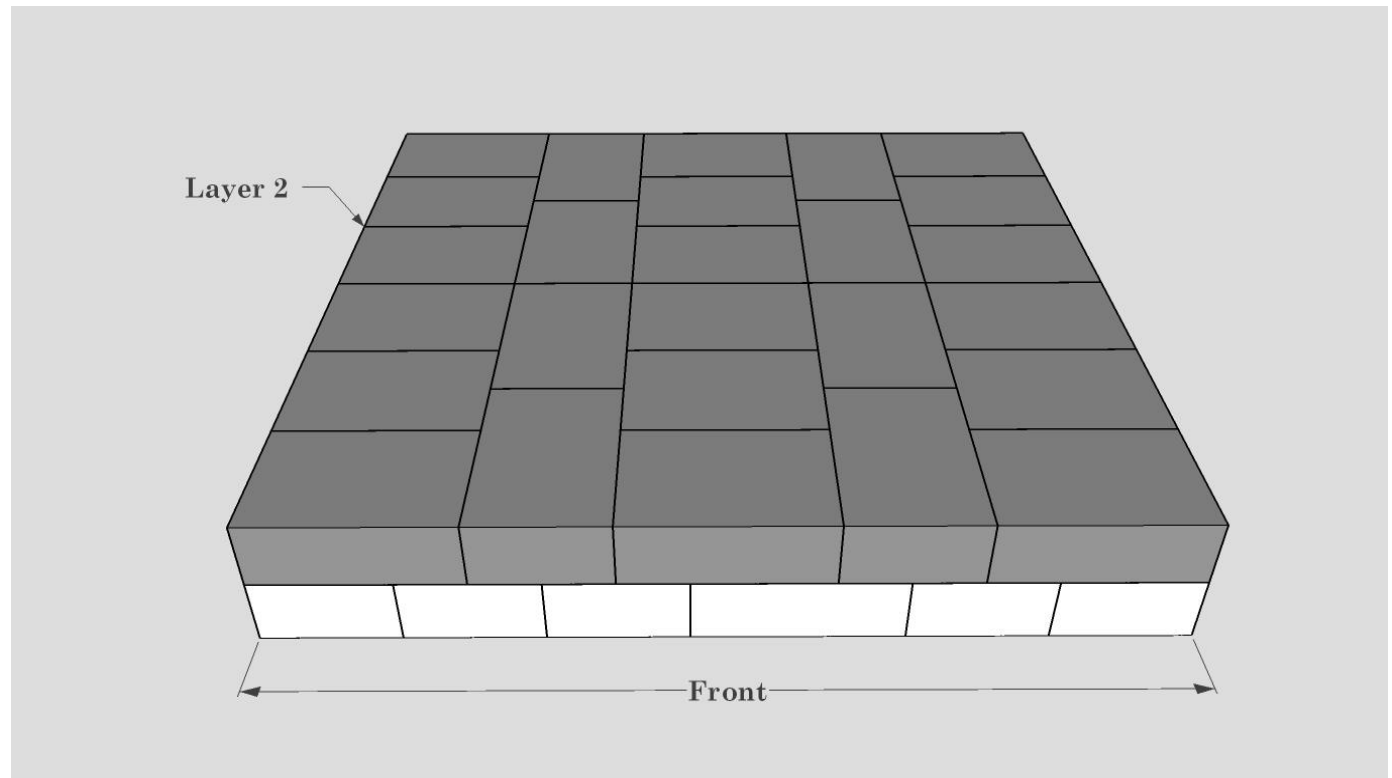

Step 3

Again insure all blocks to be glued are thoroughly brushed and clear of dust. Begin at either corner and construct the back section first, gluing all touching blocks.

ITEM	Quantity
Simplicity	29
	
Glue	
	

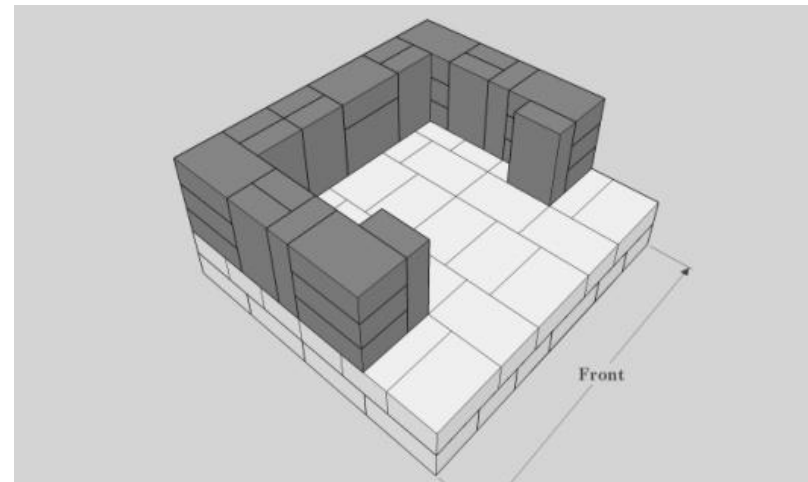
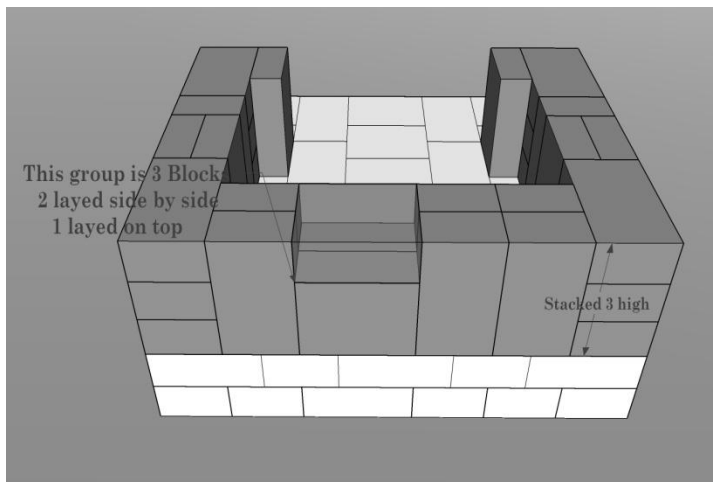
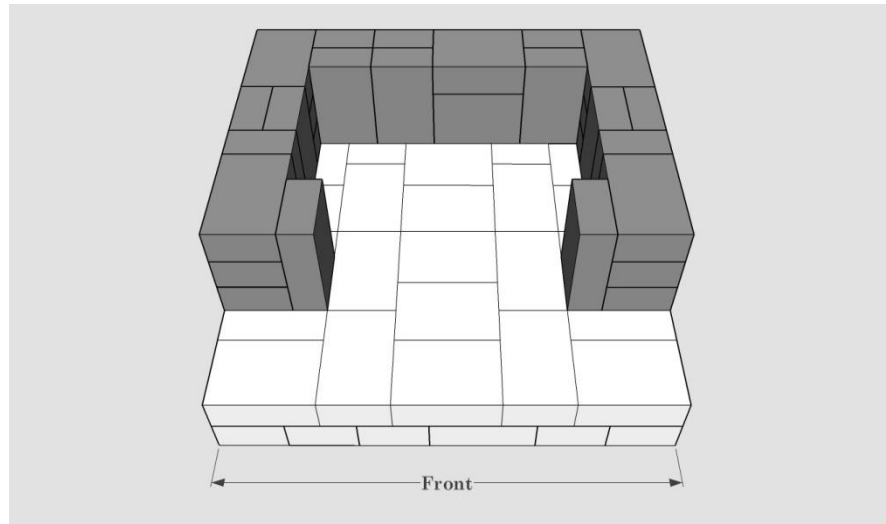



Step 4

Lay the fire brick flush with the front block, leaving a hollow space in the back corner.

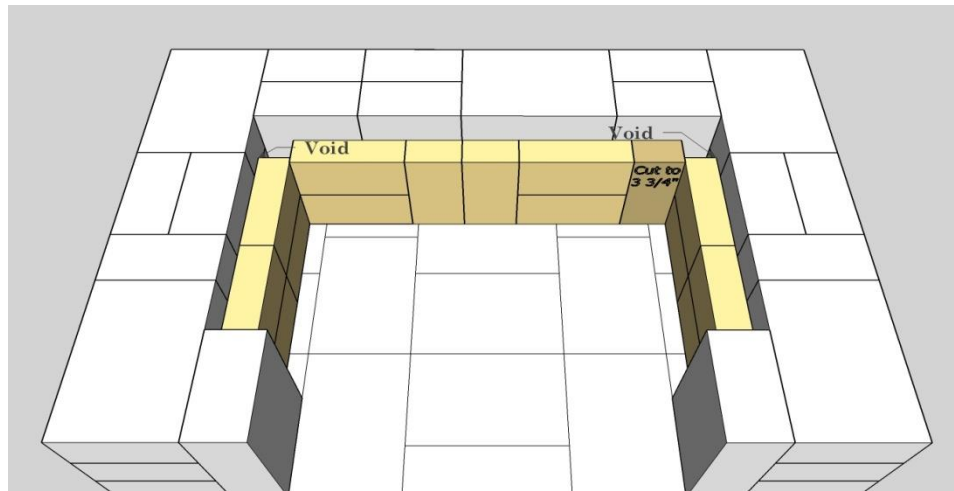
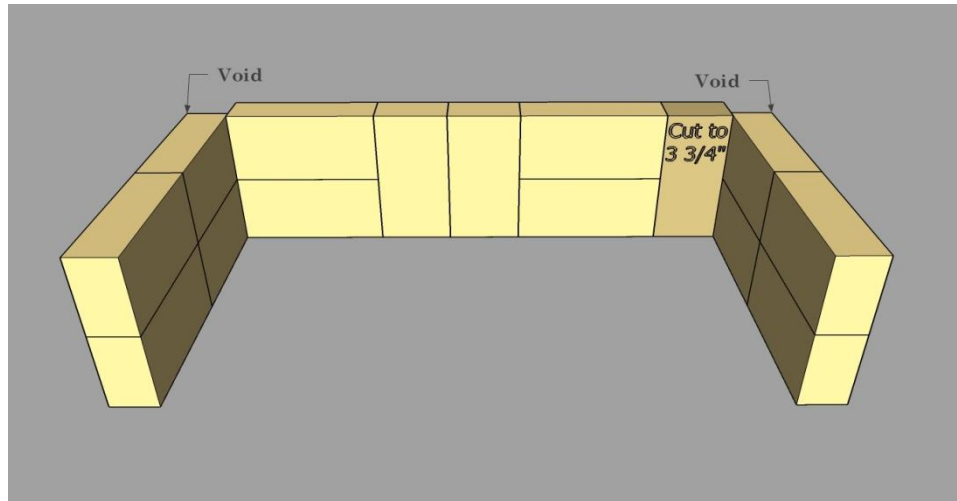
ITEM	Quantity
Fire Brick	14
Cut Fire Brick 3 3/4"	1
Glue	



Step 5

ITEM	Quantity
Simplicity	
	27
Simplicity Notch cut	
	2
Glue	
	

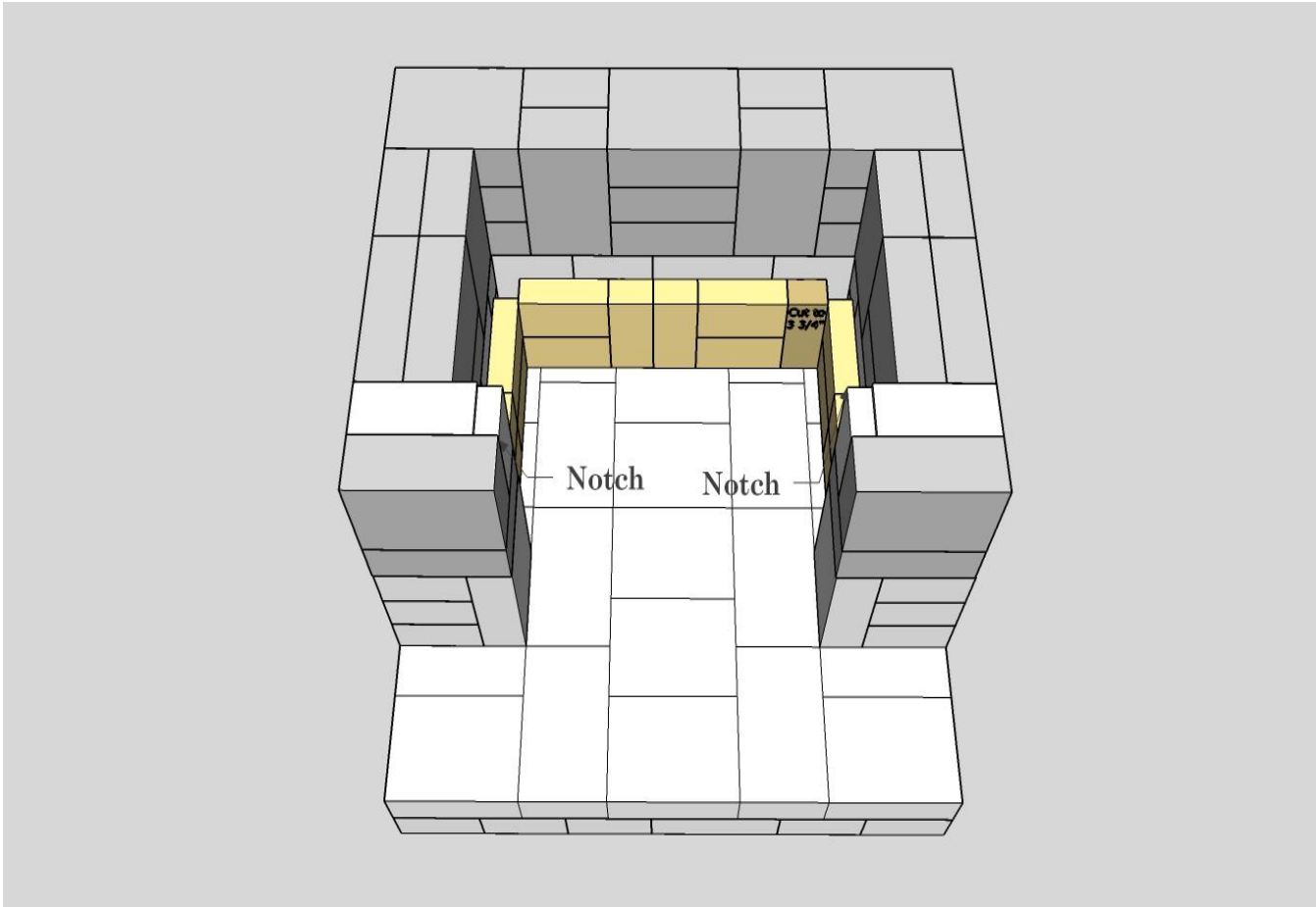

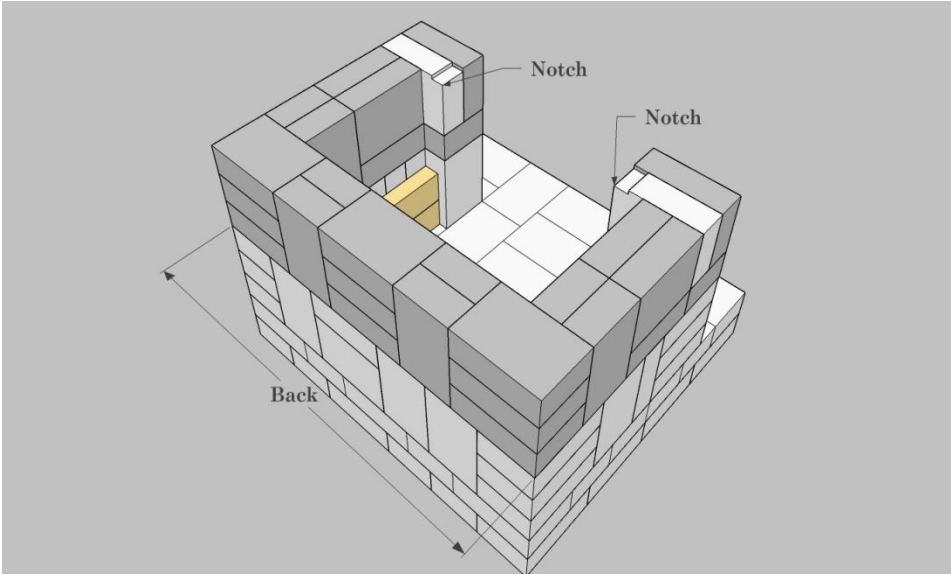
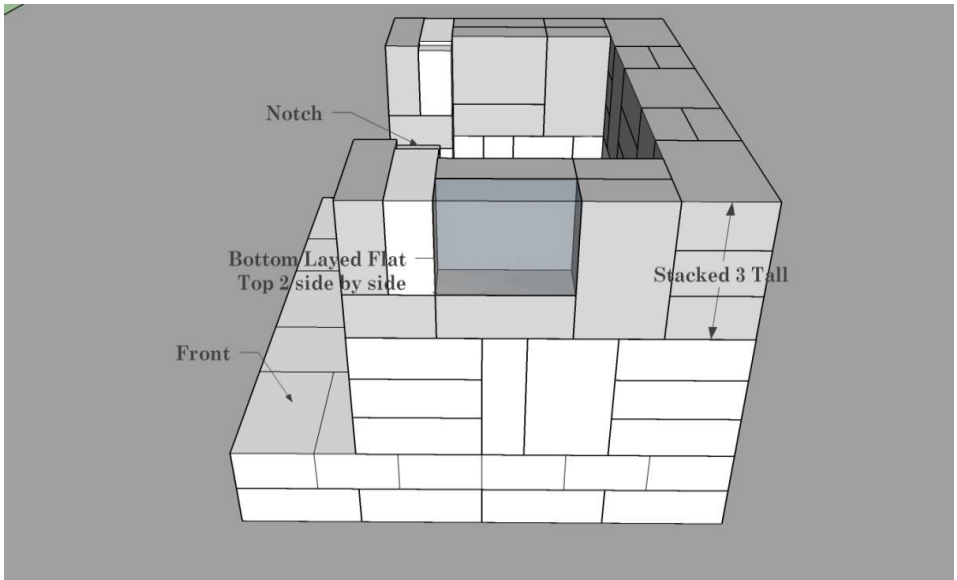

Step 6

ITEM	Quantity
Fire Brick	14
	
Cut Fire Brick 3 3/4"	1
	
Glue	
	

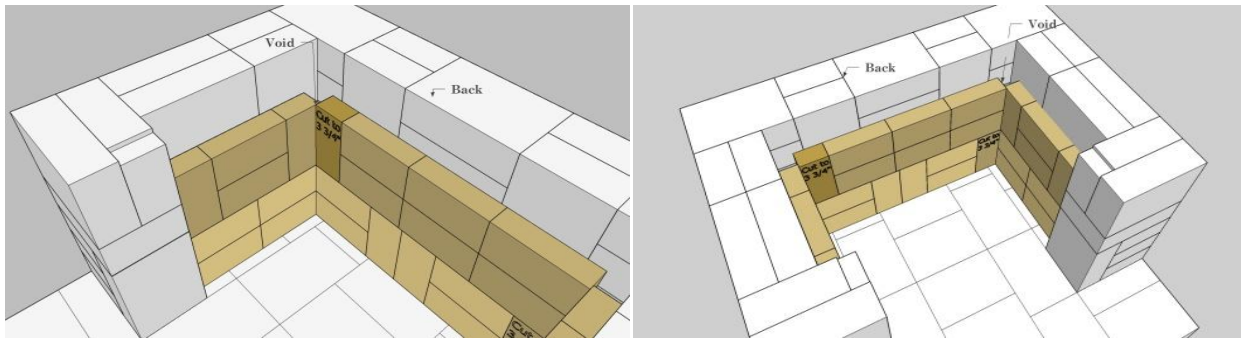
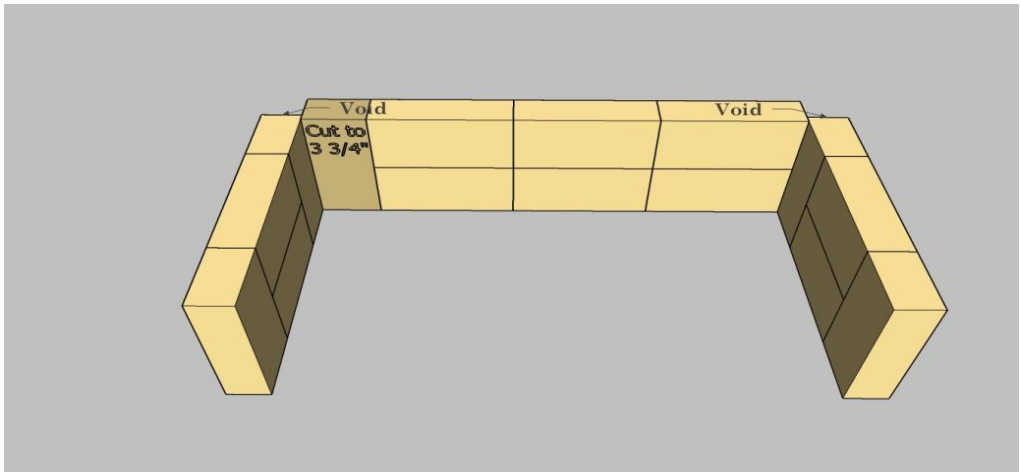

Step 7

Insure vertical portion of iron is 8 inches back from the front face of the forward most block.

ITEM	Quantity
Angle Iron 	1
Glue 	

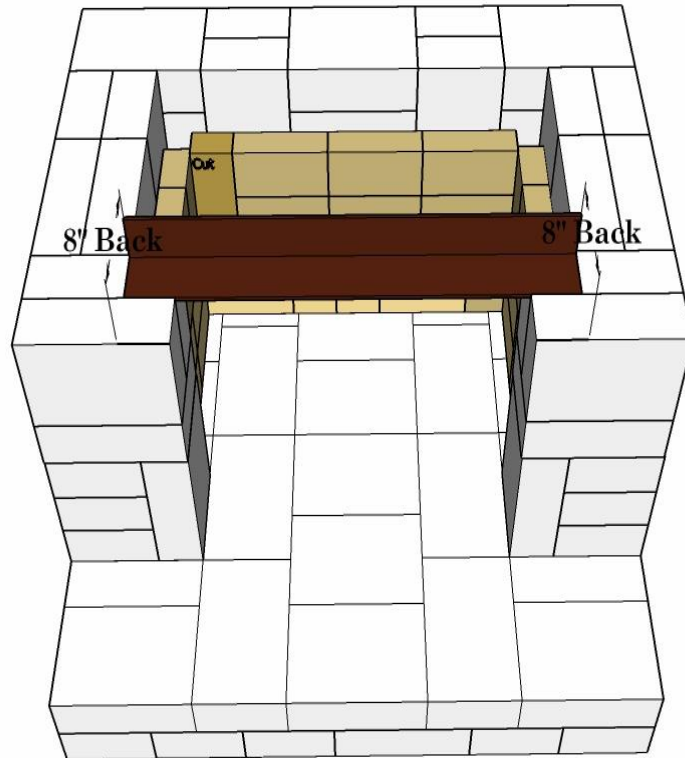

Step 8

ITEM	Quantity
Simplicity	
	37
Simplicity Cut 6 x 8 x 4	
	2
Glue	
	

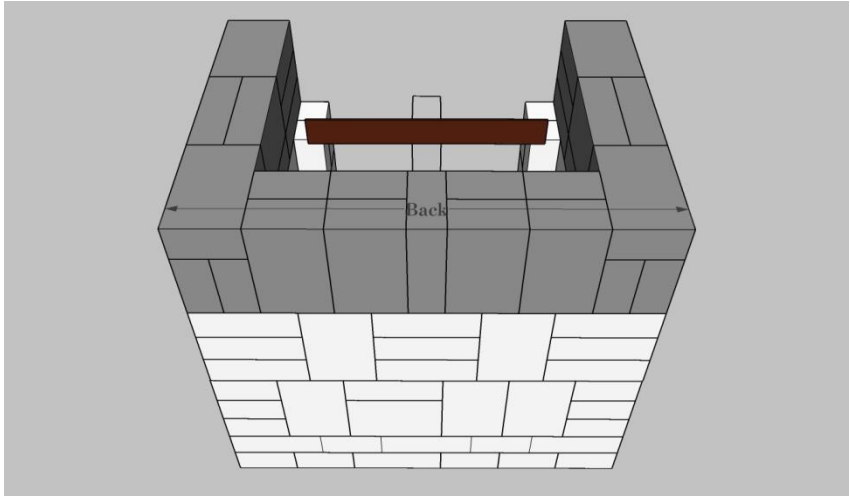
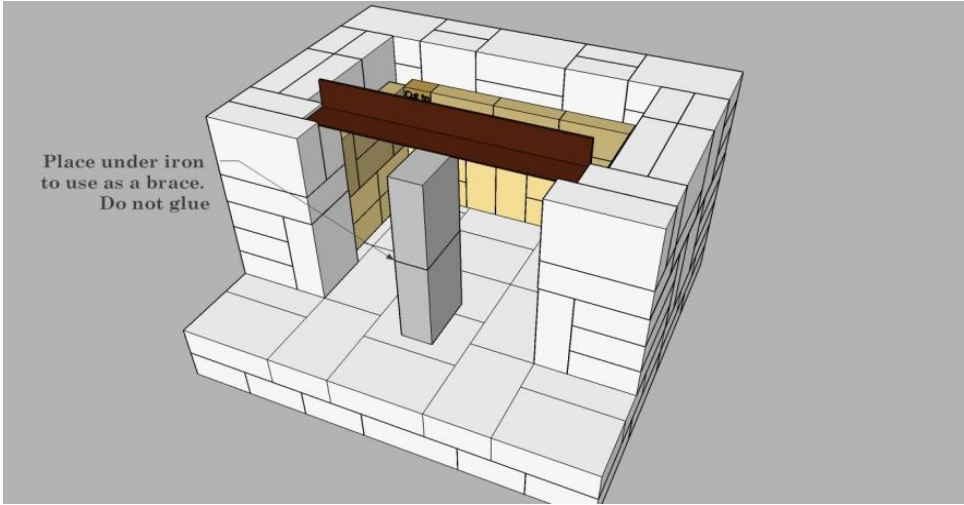

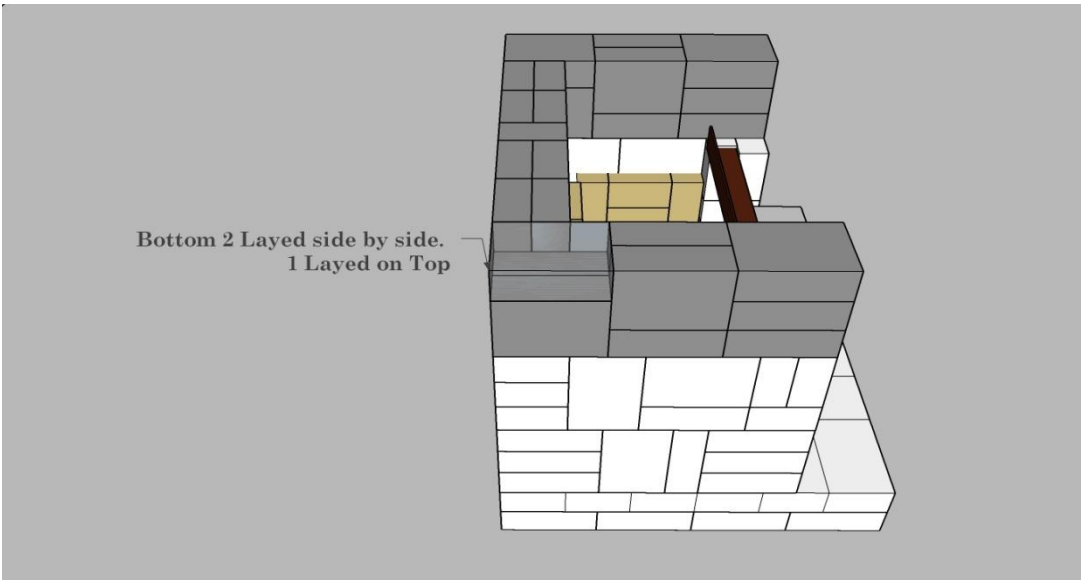

Bottom 2 Layed side by side.
1 Layed on Top

* Remove any dust from Iron
before gluing blocks to it.

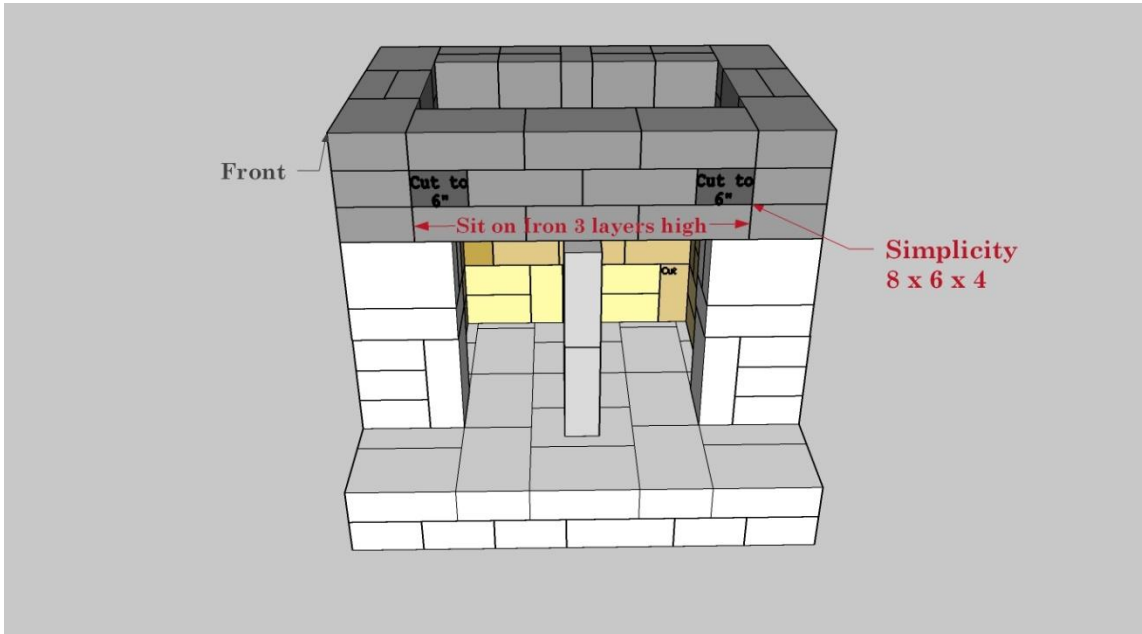

Front

Cut to
6"

Cut to
6"

Sit on Iron 3 layers high

Simplicity
8 x 6 x 4

Step 9

ITEM	Quantity
Fire Brick	14
Cut Fire Brick 3 3/4"	1
Glue	

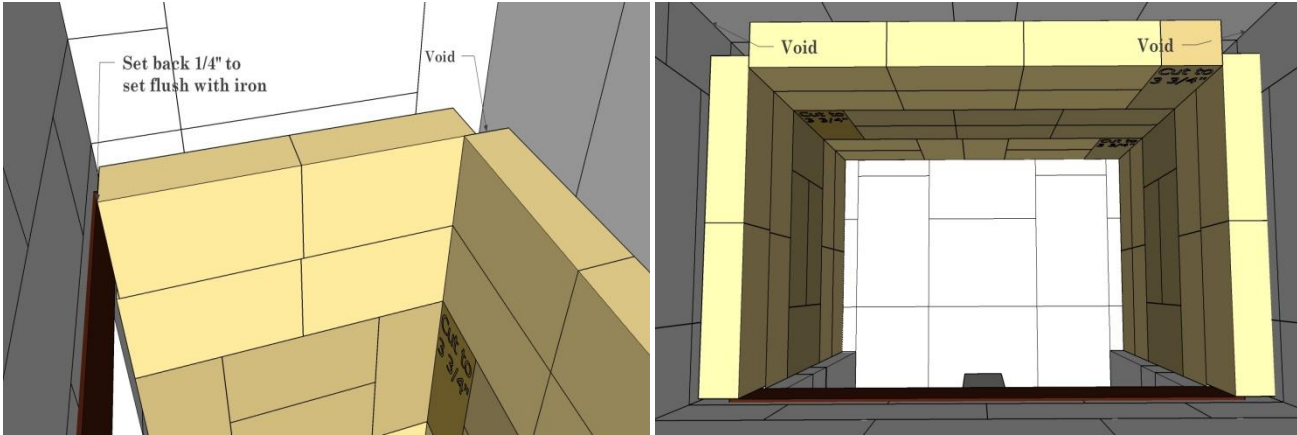
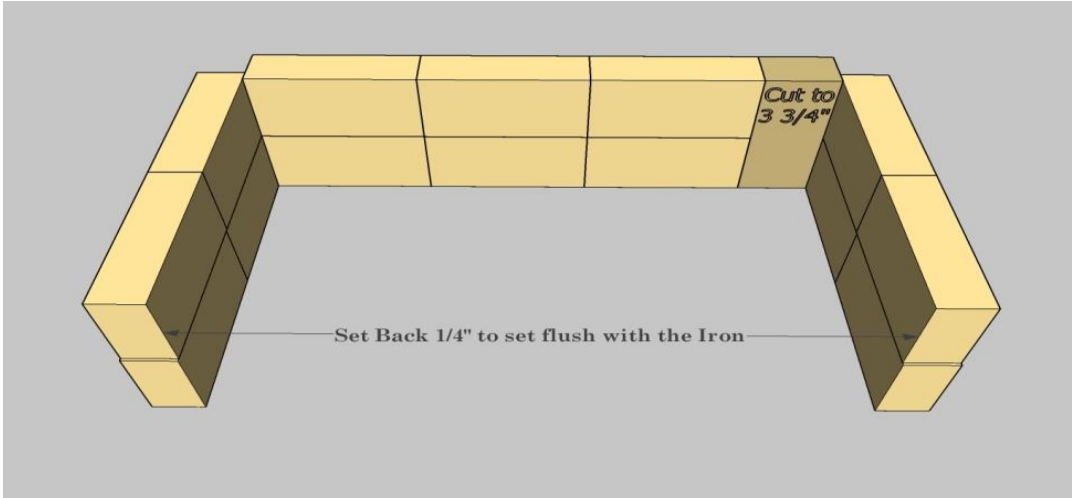

Step 10

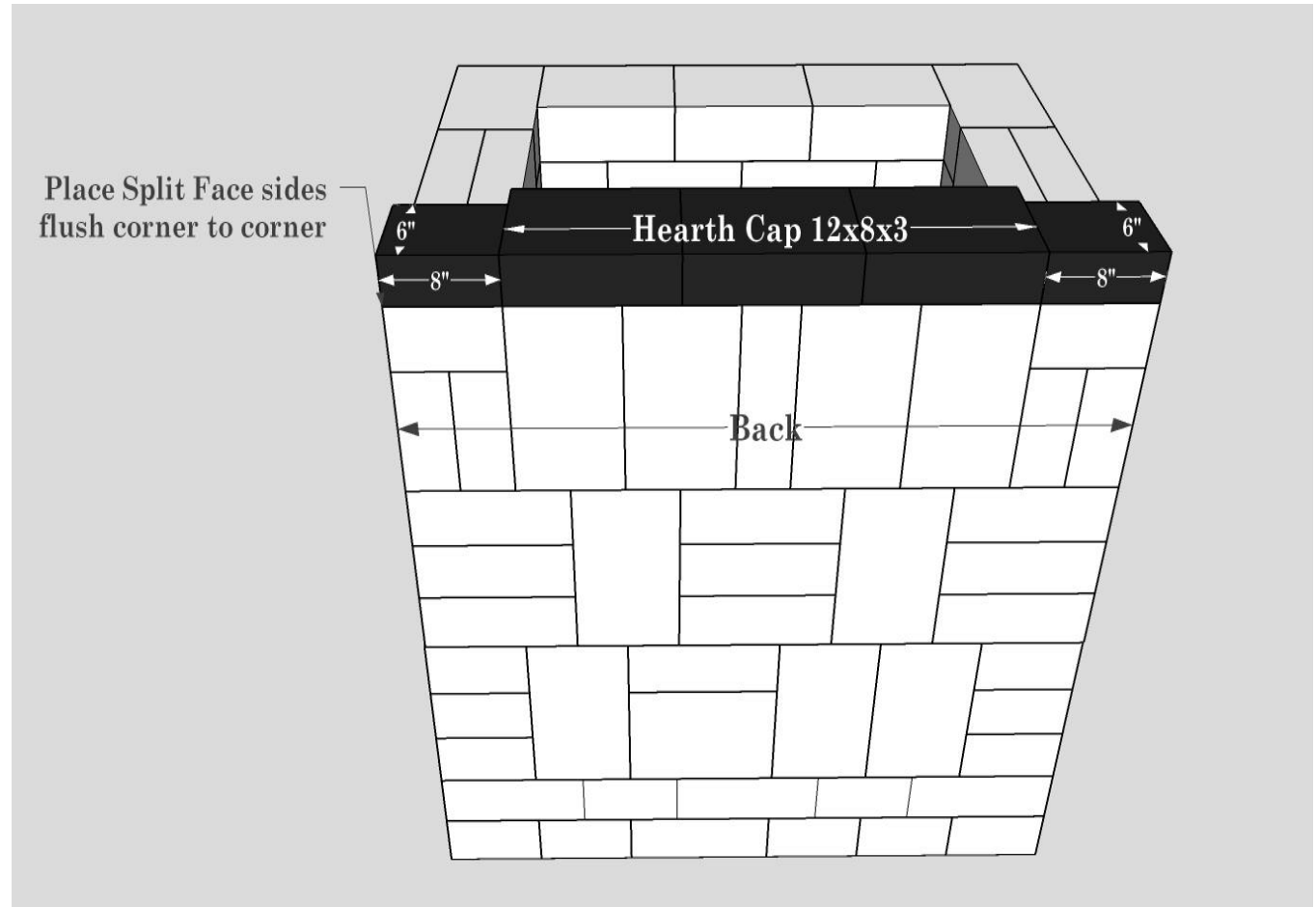

ITEM	Quantity
Hearth Cap 12 x 13 x 3	3
Hearth Cap 12 x 8 x 3	7
Hearth Front Corner Cap	2
Hearth Rear Corner Cap	2

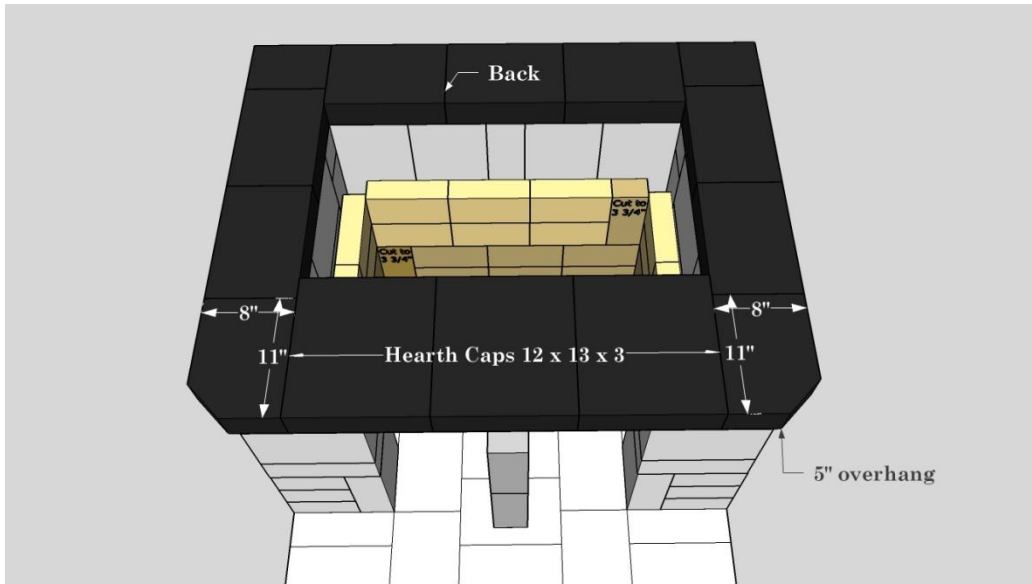
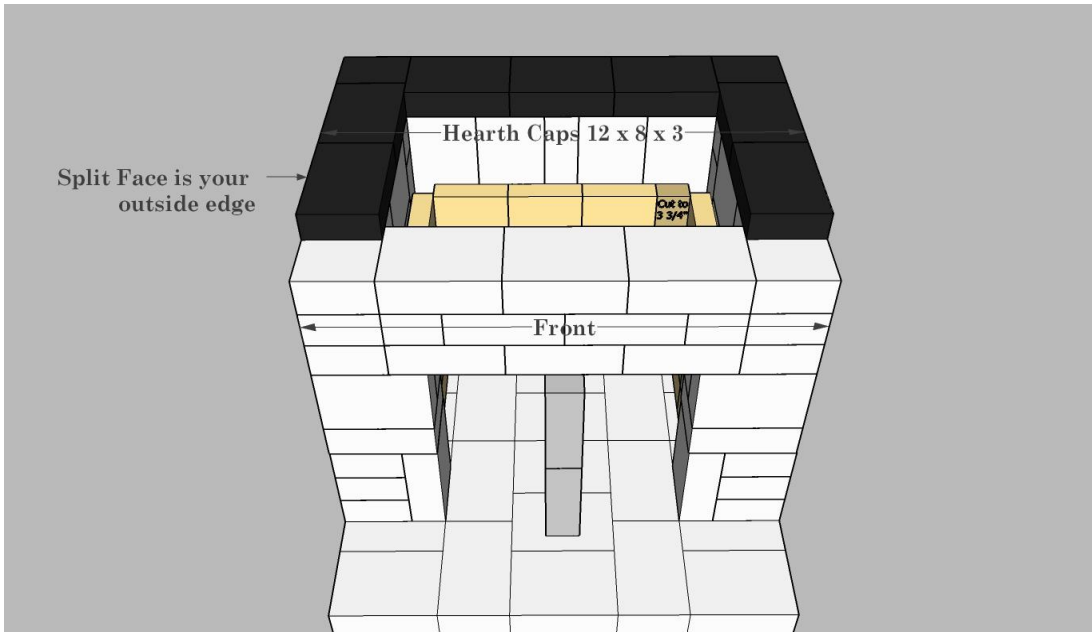

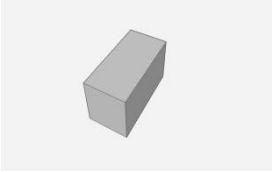

Step 11

* Using your straight edge, draw guide lines to aid in proper offset.
Repeat for all four layers

ITEM	Quantity
Simplicity	
	10
Simplicity Cut 8 x 4 x 4	
	2
Glue	
	

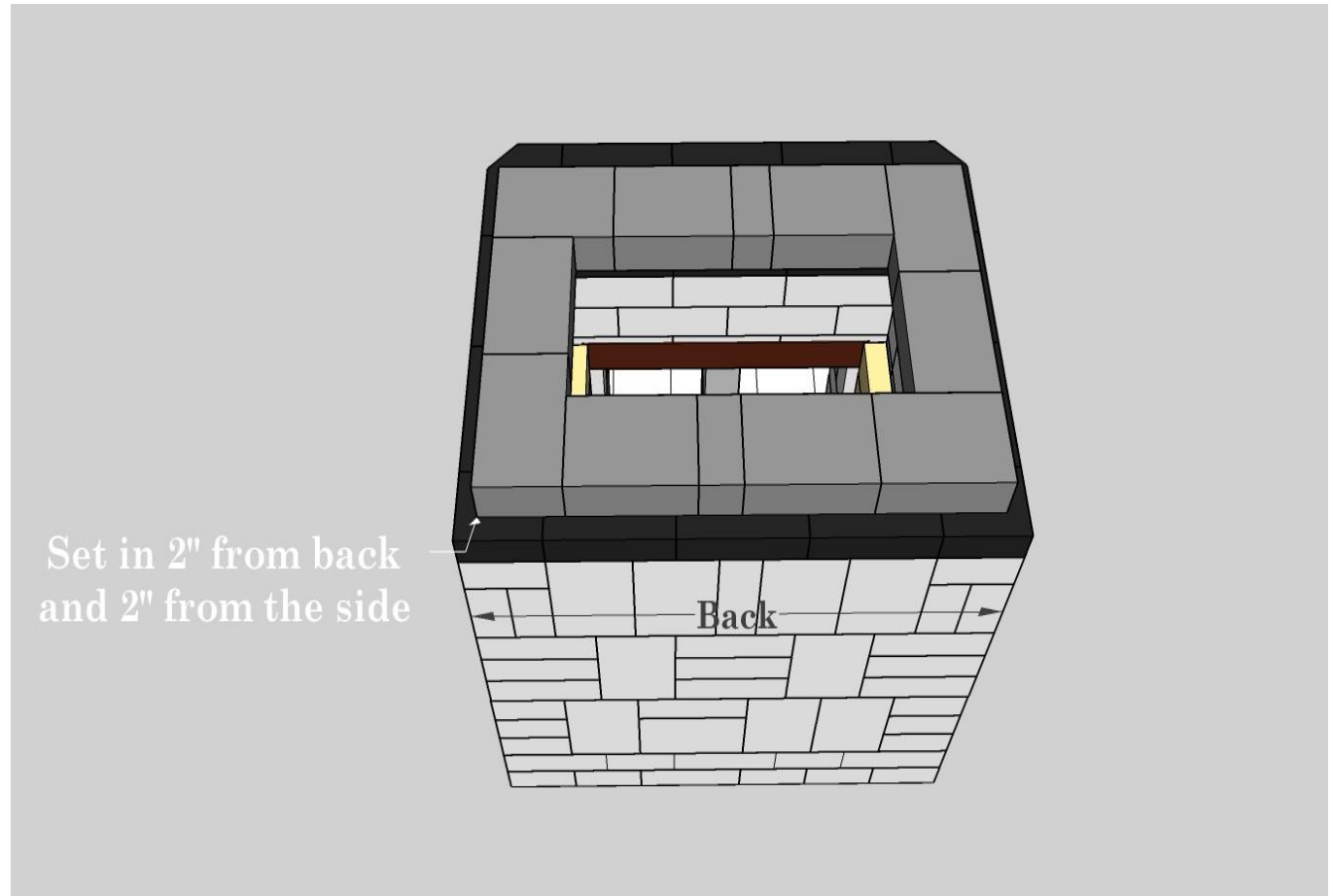

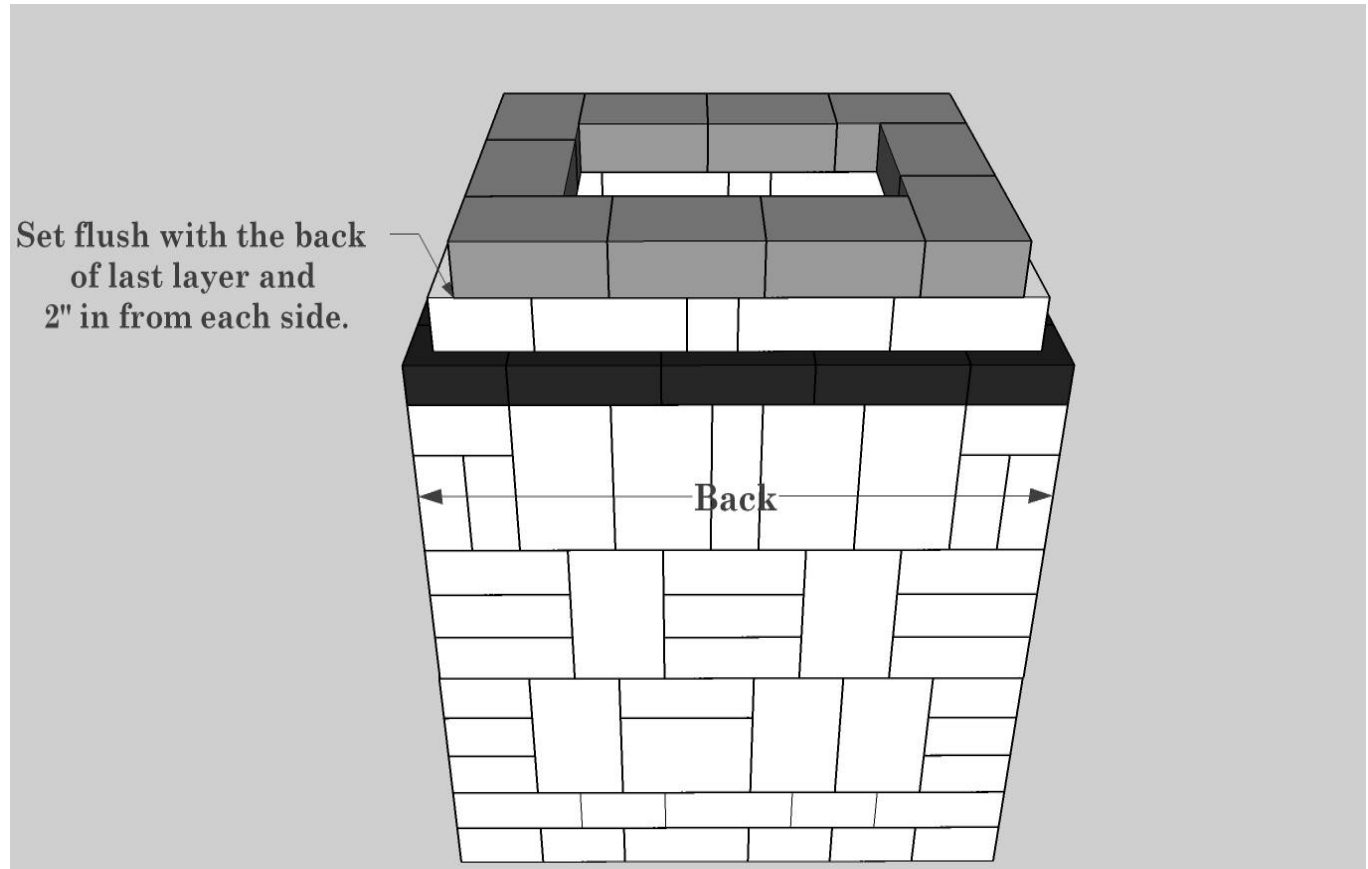

Step 12

ITEM	Quantity
Simplicity 	10
Glue 	



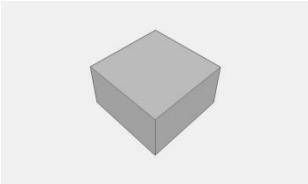

Step 13

ITEM	Quantity
Simplicity	
	8
Simplicity Cut 8 x 8 x 4	
	2
Glue	
	

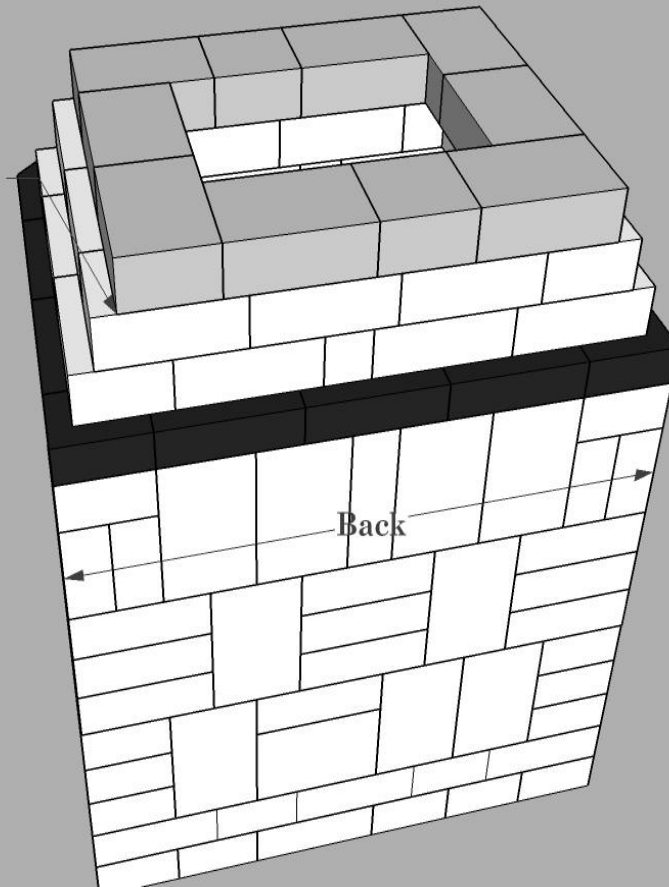
Set flush with the back of last layer and 2" in from each side.

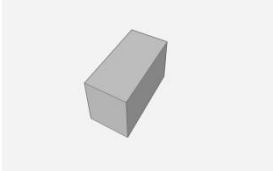

Step 14

ITEM	Quantity
Simplicity	
	8
Simplicity Cut 8 x 4 x 4	
	2
Glue	
	

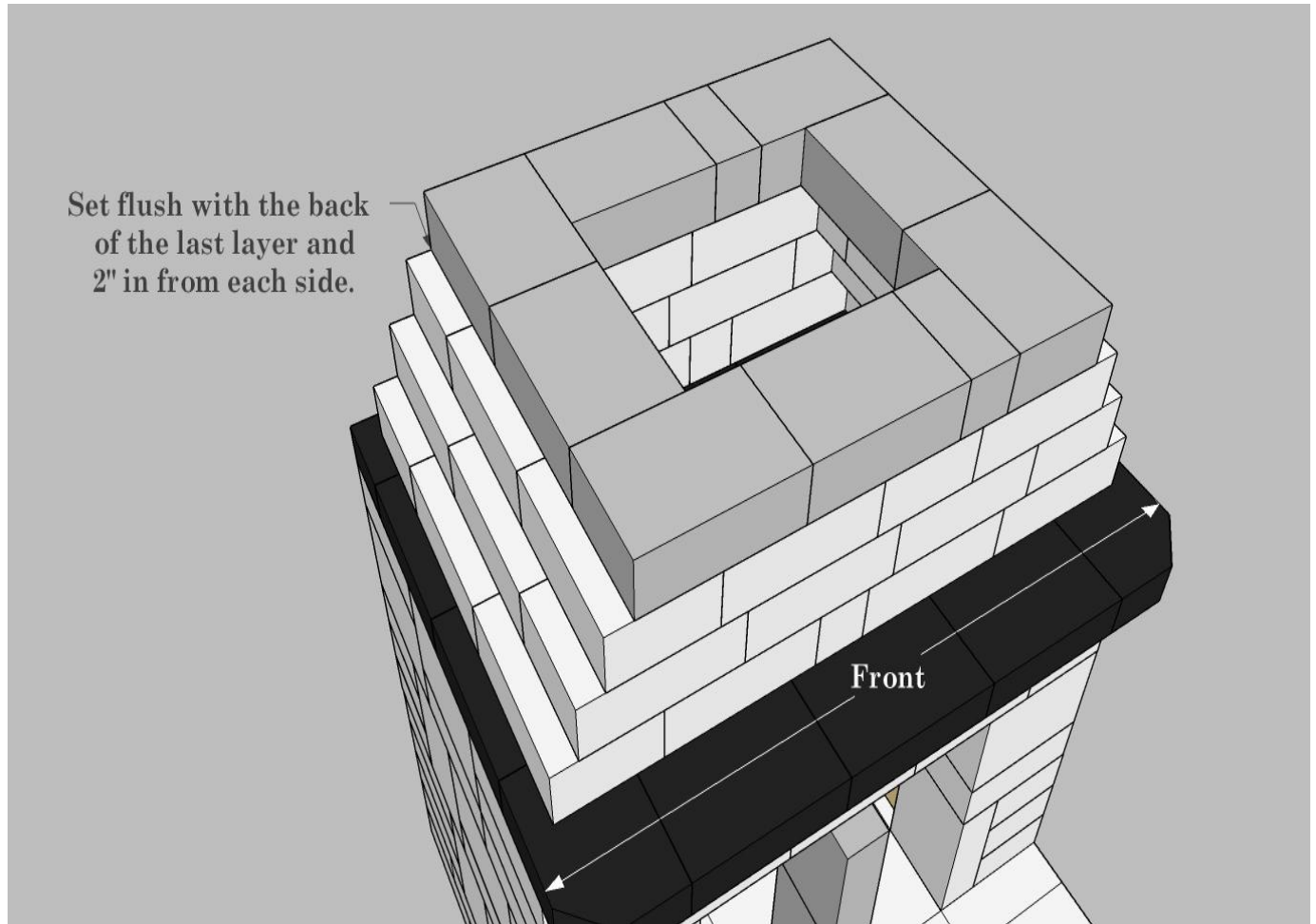

Step 15

ITEM	Quantity
Simplicity	8
Glue	

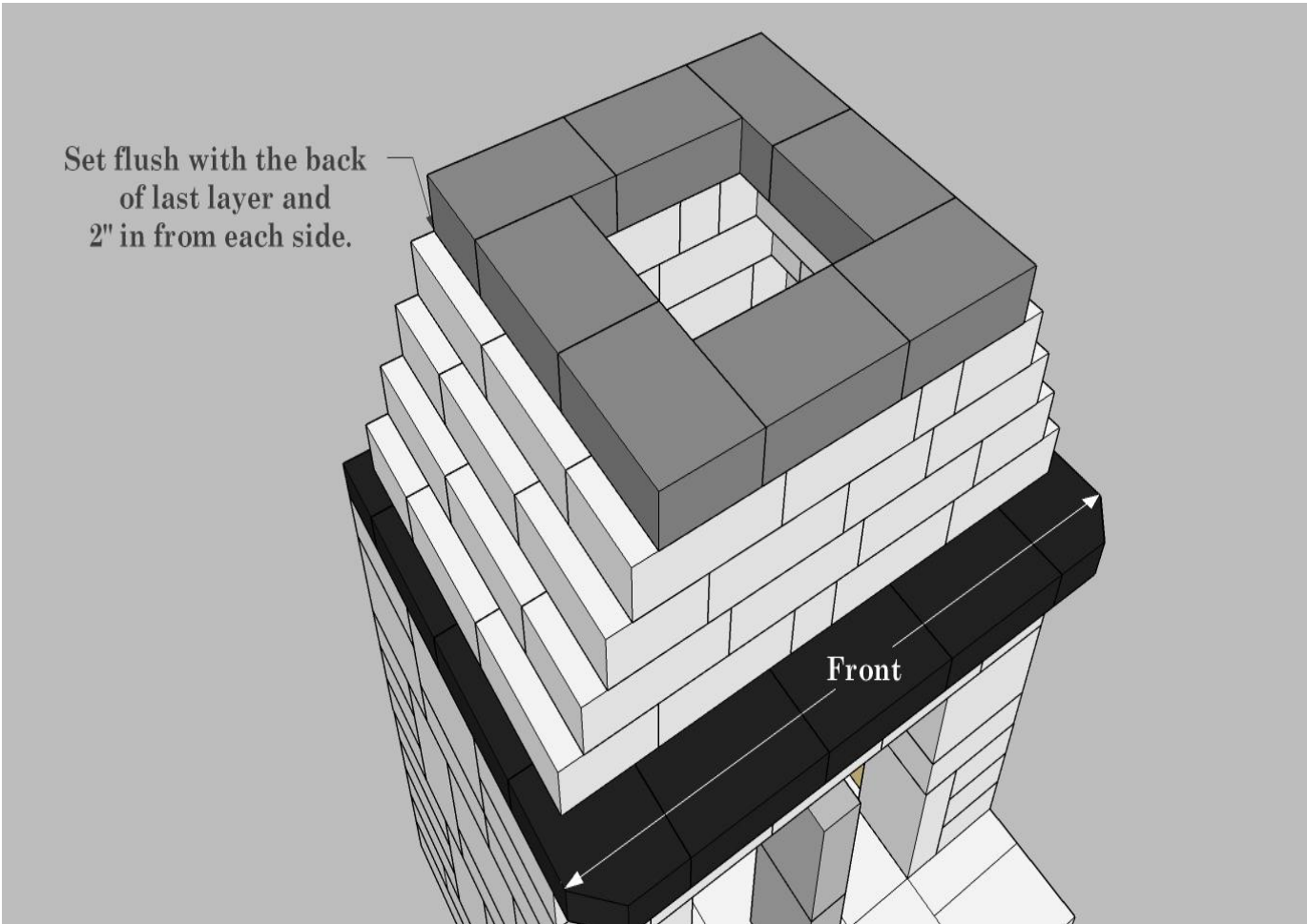

Step 16

ITEM	Quantity
Simplicity	8
	
Glue	
	

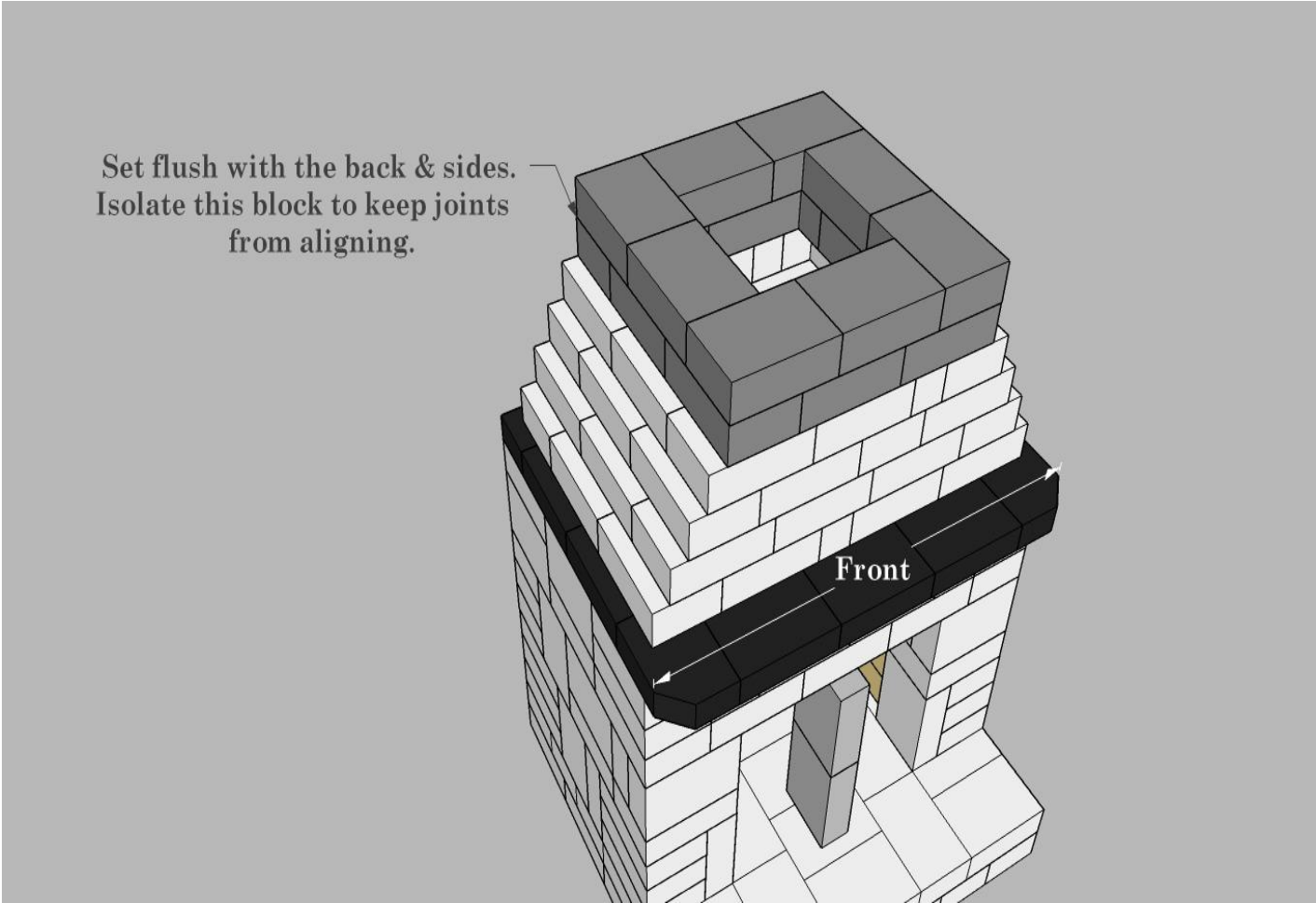

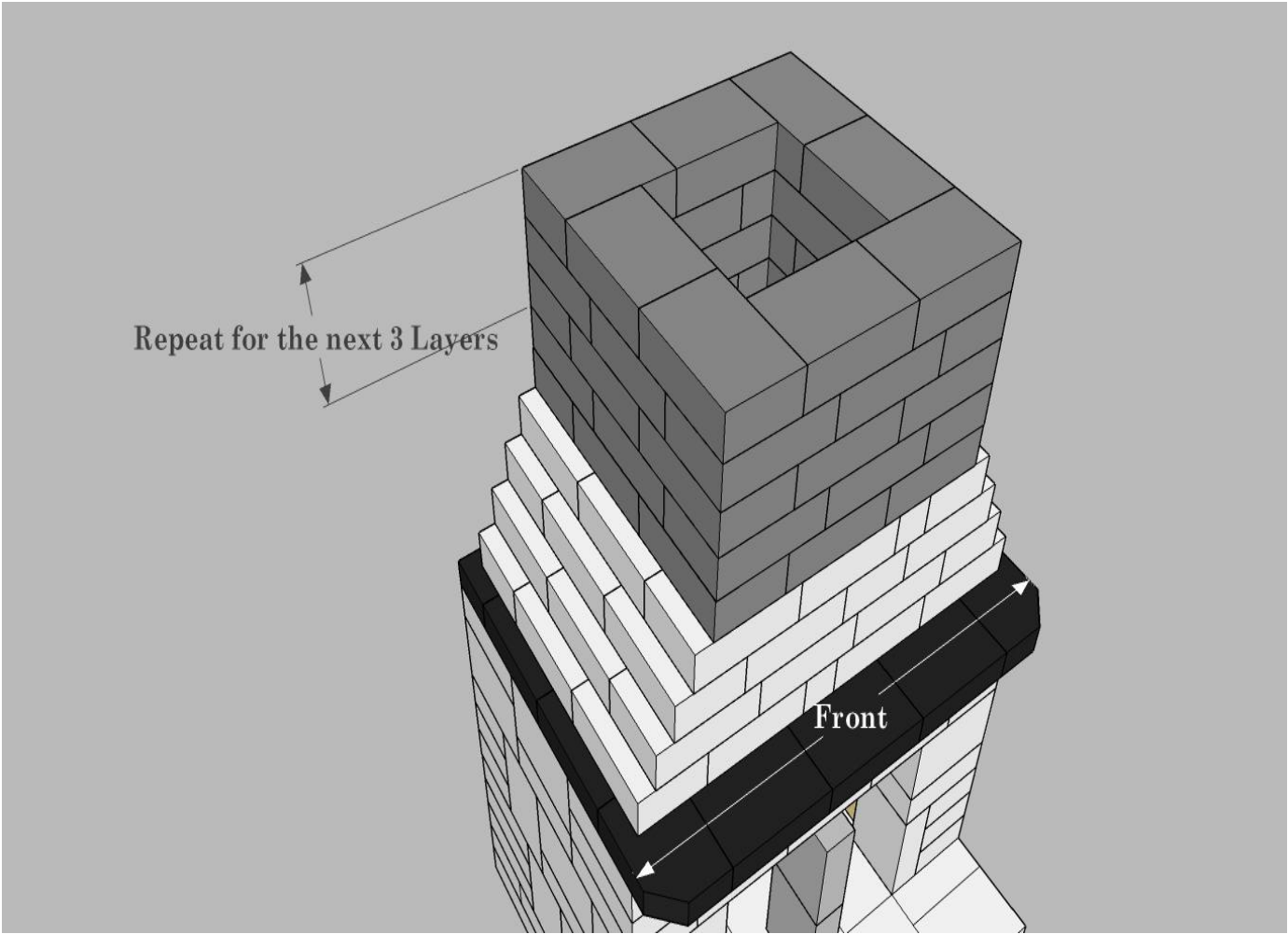

Step 17

ITEM	Quantity
Simplicity	
	24
Glue	
	

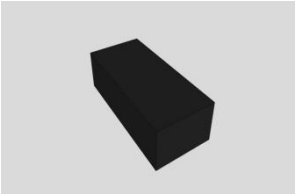
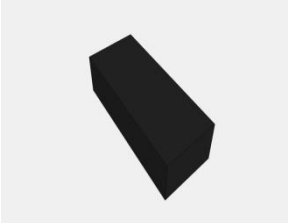

*Again use guide lines to ensure proper alignment.

Step 18

ITEM	Quantity
Top Cap 11 x 5 x 3	2
	
Top Cap 12 x 5 x 3	8
	
Glue	
	

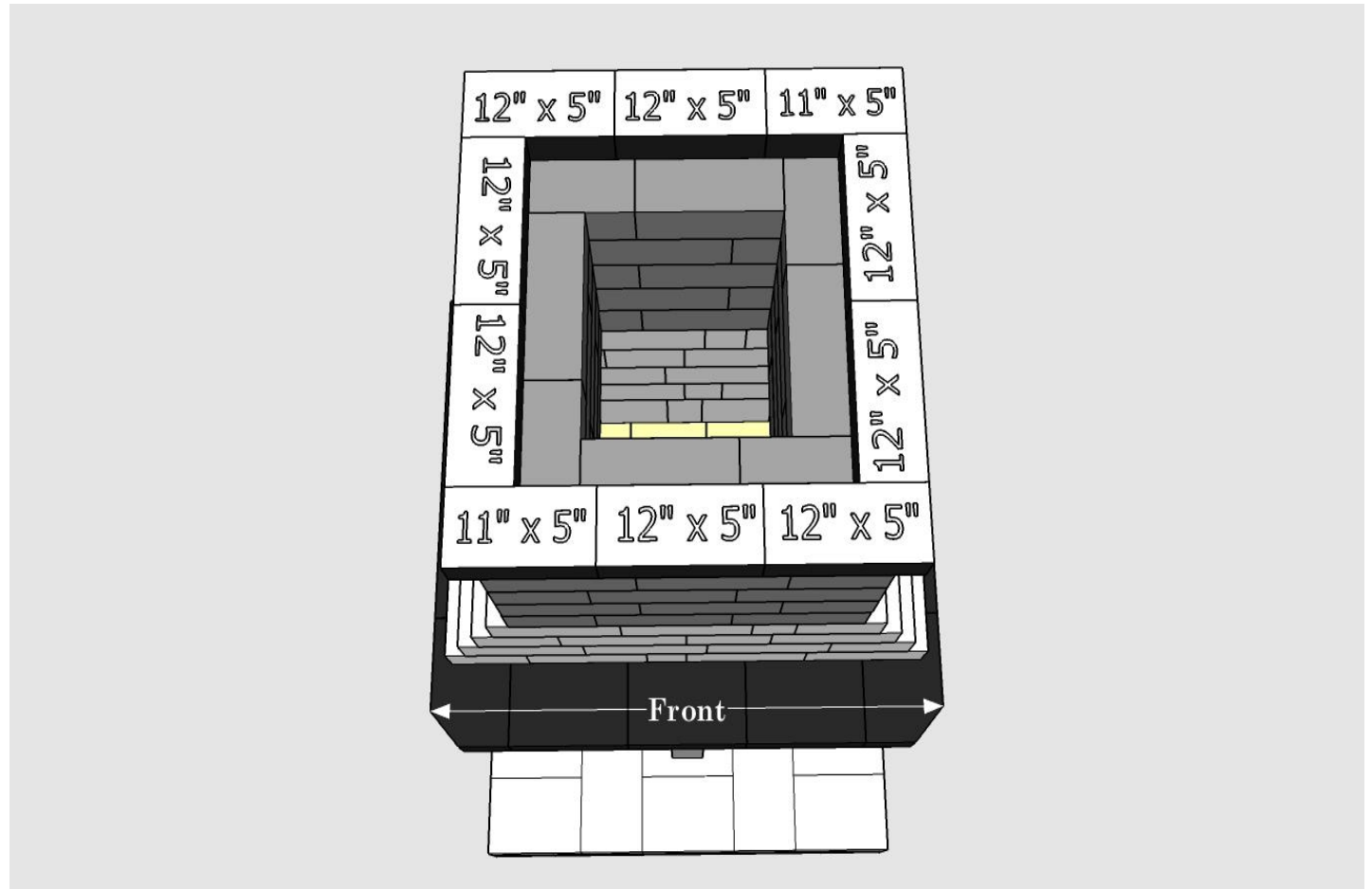

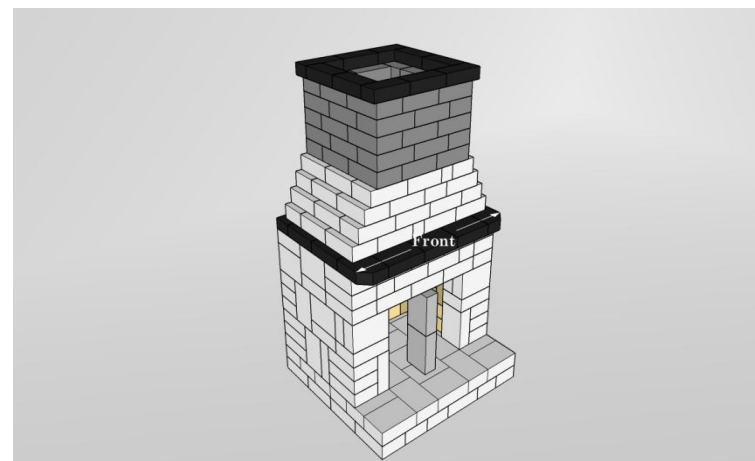
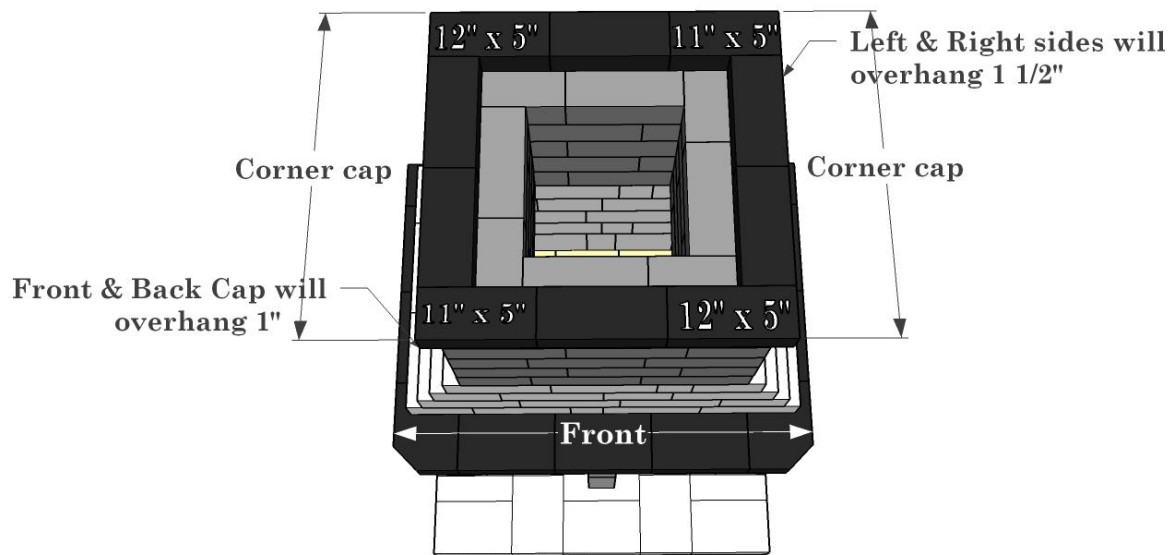

Step 19

ITEM	Quantity
Simplicity Cut 8 x 4 x 4	2
Simplicity Cut 8 x 8 x 4	4

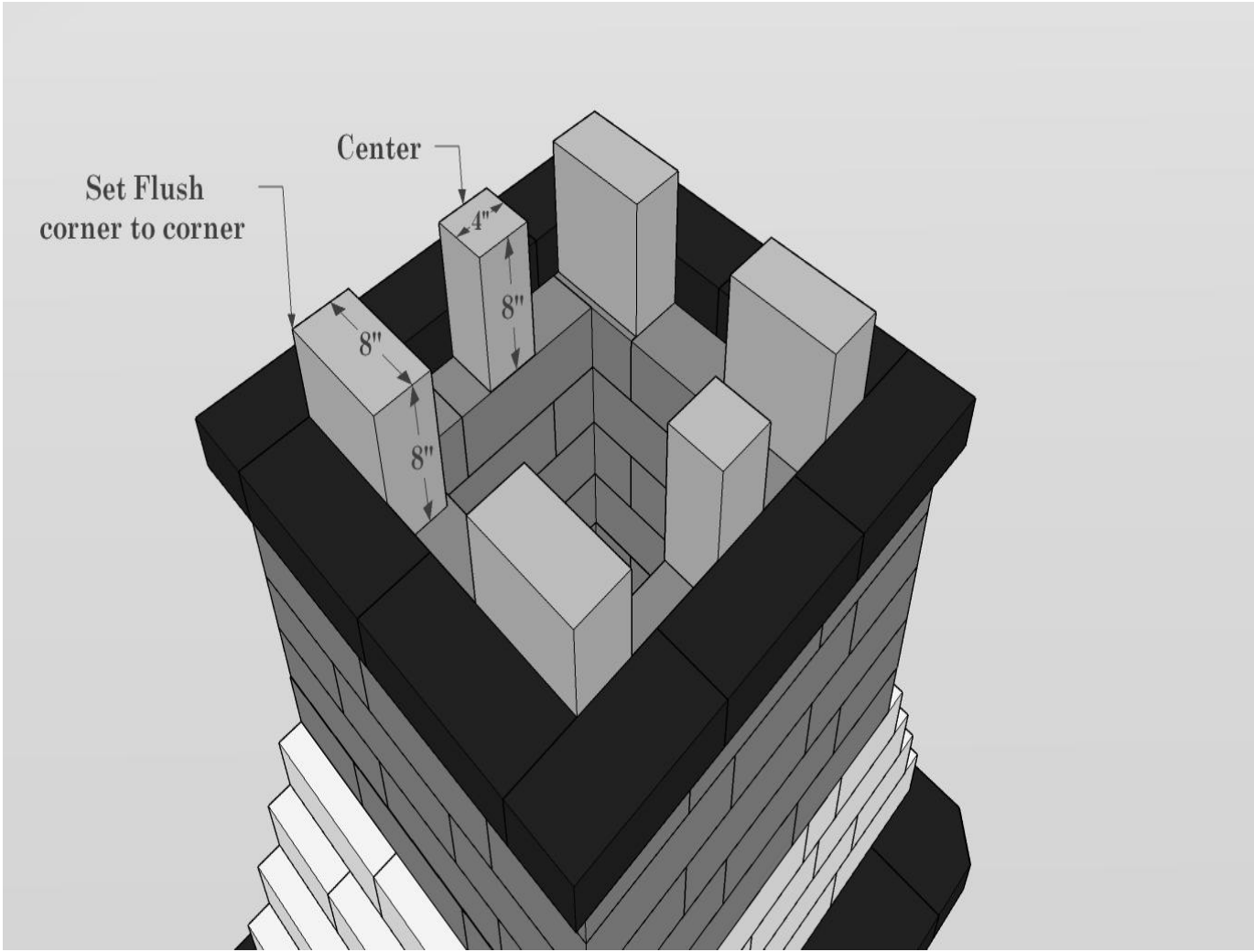

Step 20

ITEM	Quantity
Simplicity Cut 12 x 4 x 4	6
Simplicity Cut 4 x 4 x 2	4
Glue	

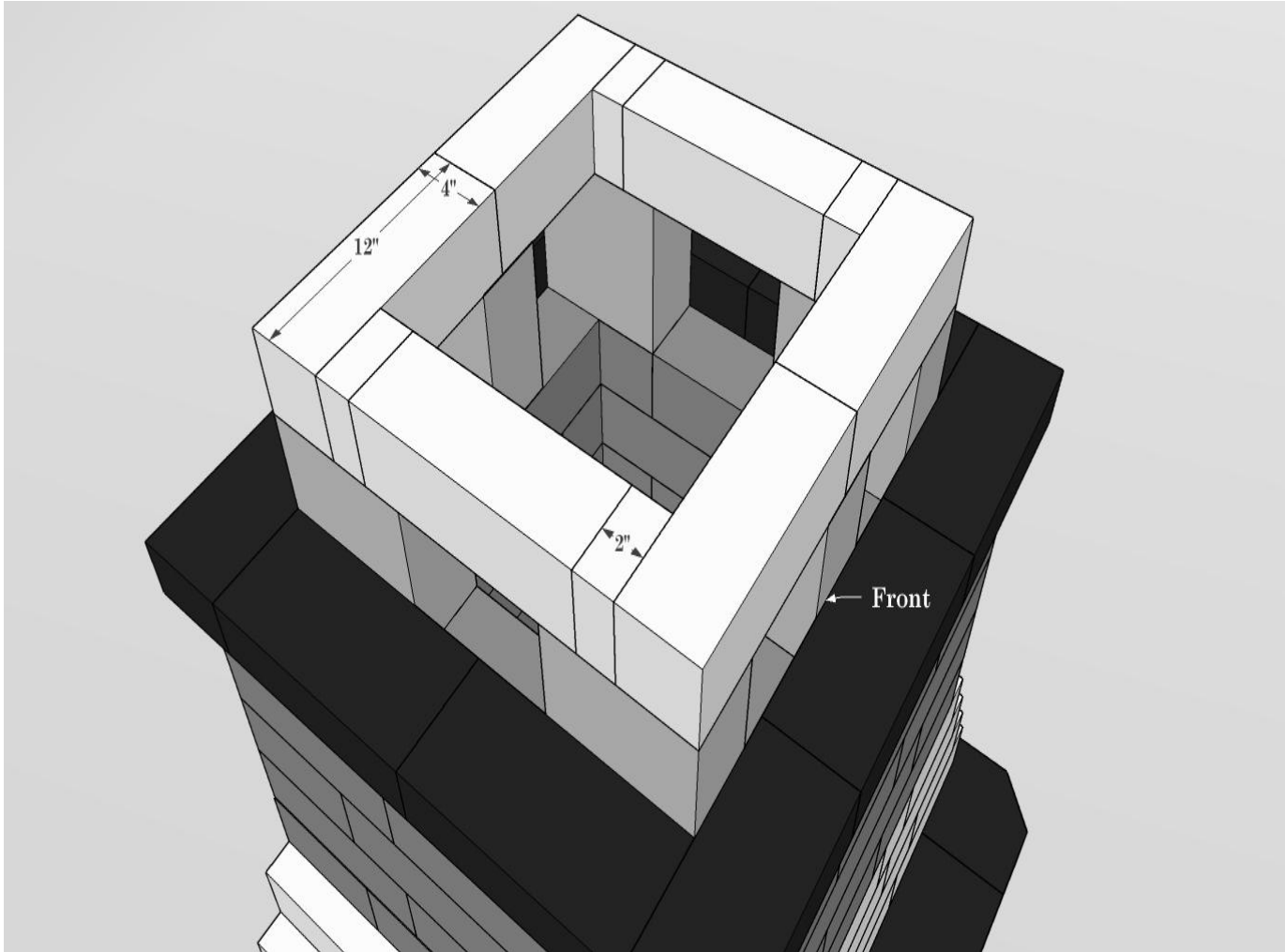

Final

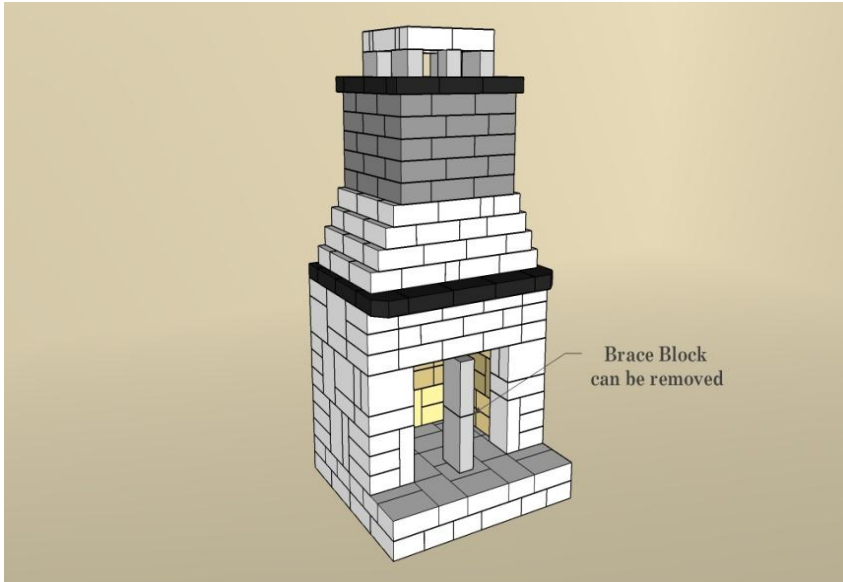

Fireplace will be 7'11" tall by 4' wide and 4'4" long

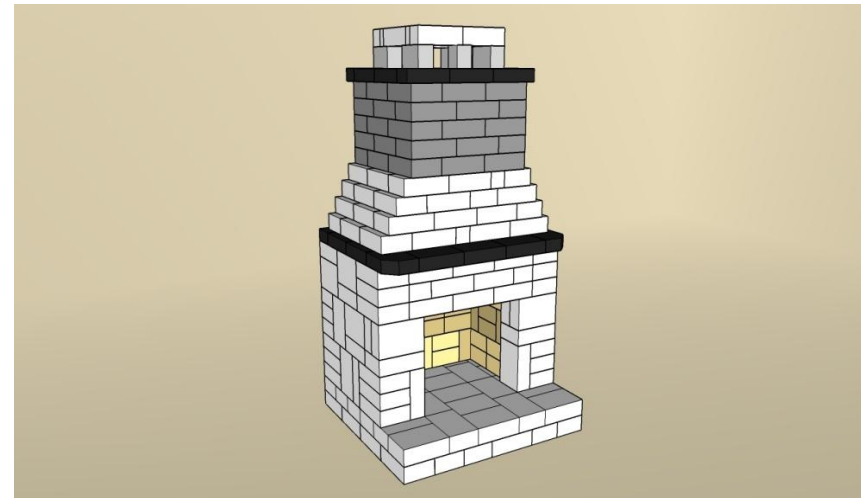

TOOLS

SQUARE 4 FOOT LEVEL
LADDER CAULK GUN
DEAD BLOW HAMMER

Item List

Simplicity 12x8x4 221ea Simplicity Notch 2ea Simplicity 8x6x4 2ea
Simplicity 12x4x4 6ea Simplicity 8x8x4 6ea Simplicity 8x4x4 6ea
Simplicity 4x4x2 4ea Fire Brick 4.5x9 42ea Cut Fire Brick 3ea
Angle Iron 1ea PL Glue 10 Tubes

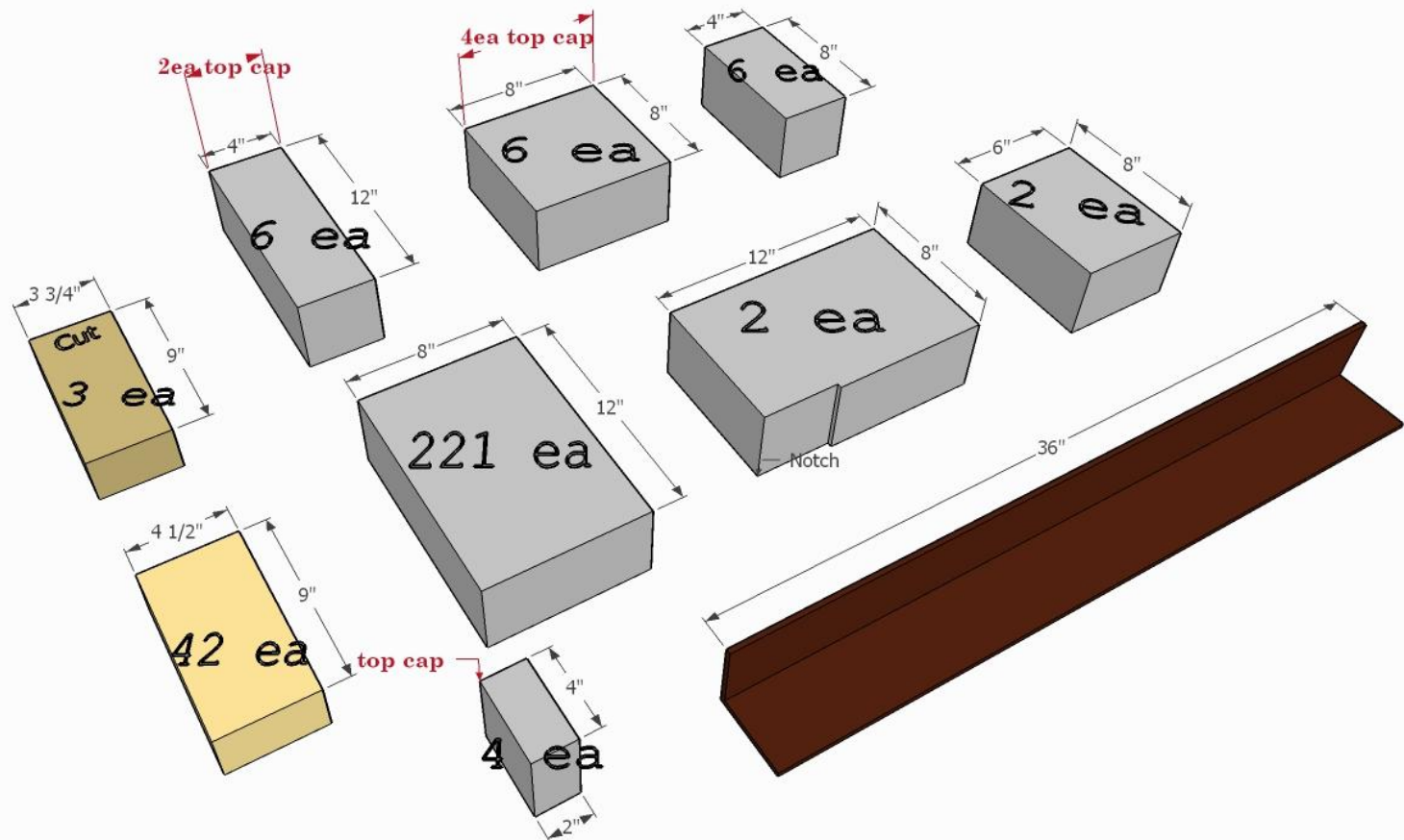

Item List

Hearth Cap 12x13x3 3ea
Hearth Front Corner Cap 2ea

Hearth Cap 12x8x3 7ea
Hearth Rear Corner Cap 8x6x3 2ea

